



MBU SERIES

Undercounter/Worktable Refrigerators & Freezers

MBUF/MBUR60



REFRIGERATORS

- MBUR27
- MBUR36
- MBUR48
- MBUR60
- MBUR72

FREEZERS

- MBUF27
- MBUF48
- MBUF60

FEATURES

CONSTRUCTION

- Stainless steel interior and exterior
- Foamed-in-place with low ODP polyurethane insulation
- Wall thickness: 2"
- 6" overall height casters
- Adjustable heavy-duty shelves, one per door

DOORS

- Self-closing with heavy-duty recessed pocket handle
- Standard door swing configuration:
 - 1-door models hinged right
 - 2-door models.....left hinged left, right hinged right
 - 3-door model.....left hinged left, middle door hinged left, right door hinged right
- Field reversible doors on MBUR27 & MBUF27 models

Door width:

- MBUR/MBUF27 27³/₈"
- MBUR36..... 18"
- MBUR/MBUF48.....24"
- MBUR/MBUF60..... 30"
- MBUR72.....24"

REFRIGERATION

- Self-contained forced air capillary tube refrigeration system
- Refrigerant: R290
- Temperature range:
 - MBUR.....34° to 38°F (1° to 3°C)
 - MBUF.....-5° to 0°F (-20° to -17°C)

WARRANTY

- **Standard limited three year parts and labor**
- **Additional two year coverage on compressor part**

OPTIONS

- Additional shelves
- 4" casters in lieu of 6" casters (shipped loose)
- 6" legs in lieu of casters (shipped loose)
- Single or double overshef

REFRIGERATORS

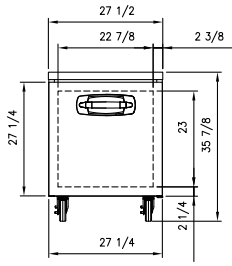

MBUR27

FRONT VIEW

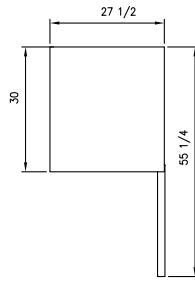

TOP VIEW

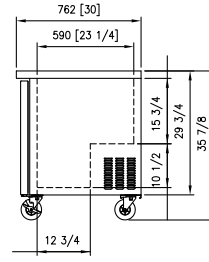

ALL MODELS
SIDE VIEW

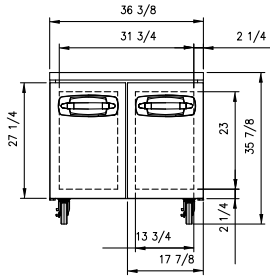

MBUR36

FRONT VIEW

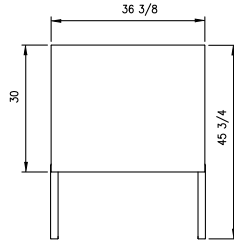

TOP VIEW

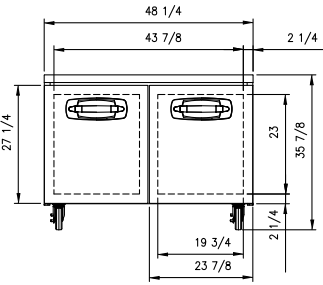

MBUR48

FRONT VIEW

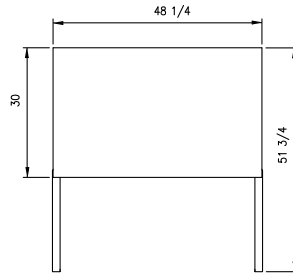

TOP VIEW

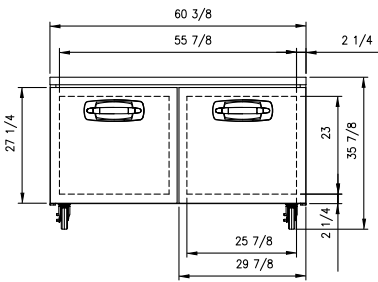

MBUR60

FRONT VIEW

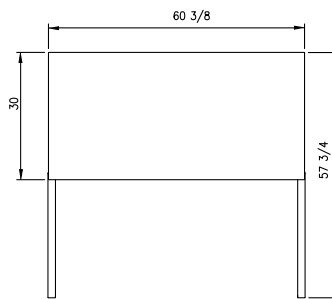

TOP VIEW

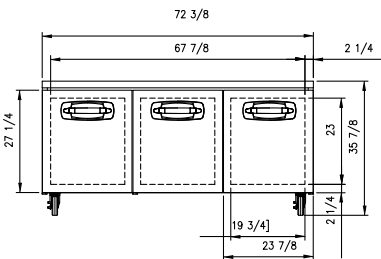

MBUR72

FRONT VIEW

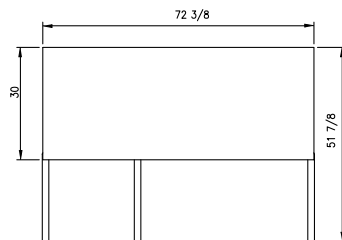

TOP VIEW

SPECIFICATIONS

Models	MBUR27	MBUR36	MBUR48	MBUR60	MBUR72
Crated Weight (lbs) (kg)	134 (61)	170 (77)	209 (95)	231 (105)	267 (121)
Crated Height (in) (mm)	36 (914)	36 (914)	36 (914)	36 (914)	36 (914)
Crated Width (in) (mm)	30-1/8 (765)	38 (965)	51-1/4 (1302)	63 (1600)	74-3/8 (1889)
Crated Depth (in) (mm)	33-1/2 (851)	33-1/2 (851)	33-1/2 (851)	33-1/2 (851)	33-1/2 (851)
Interior Height (in) (mm)	26-1/4 (667)	26-1/4 (667)	26-1/4 (667)	26-1/4 (667)	26-1/4 (667)
Interior Width (in) (mm)	23-5/8 (600)	32-1/2 (826)	44-5/8 (1133)	56-5/8 (1438)	68-5/8 (1743)
Interior Depth (in) (mm)	22 (559)	22 (559)	22 (559)	22 (559)	22 (559)
Overall Height (in) (mm)	35-7/8 (911)	35-7/8 (911)	35-7/8 (911)	35-7/8 (911)	35-7/8 (911)
Overall Width (in) (mm)	27-1/2 (699)	36-3/8 (924)	48-1/4 (1226)	60-3/8 (1534)	72-3/8 (1838)
Overall Depth (in) (mm)	30 (762)	30 (762)	30 (762)	30 (762)	30 (762)
Gross Cubage (CuFt) (L)	6.7 (190)	9.1 (258)	12.5 (354)	15.9 (450)	19.2 (543)
Number of Shelves	1	2	2	2	3
Shelf Area (SqFt) (Sqm)	3.6 (0.33)	5 (0.46)	6.8 (0.63)	8.6 (0.80)	10.5 (0.93)
Number of Casters	4	4	4	4	4
Condensing Unit Size	1/5 HP	1/5 HP	1/5 HP	1/5 HP	1/5 HP
Refrigerant	R290	R290	R290	R290	R290
Electrical Characteristics	115/60/1	115/60/1	115/60/1	115/60/1	115/60/1
Cord and Plug Furnished	Yes	Yes	Yes	Yes	Yes
NEMA Plug Configuration	5-15P	5-15P	5-15P	5-15P	5-15P
Total Amp Draw	3.5	3.5	3.5	3.5	3.5

Specifications subject to change without notice.

FREEZERS

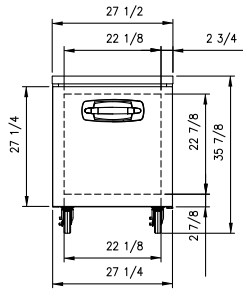

FRONT VIEW

MBUF27

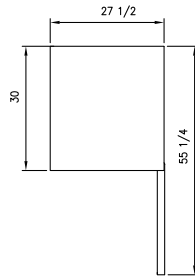

TOP VIEW

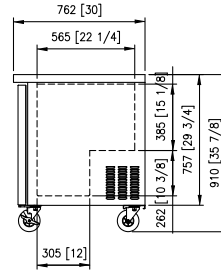

ALL MODELS
SIDE VIEW

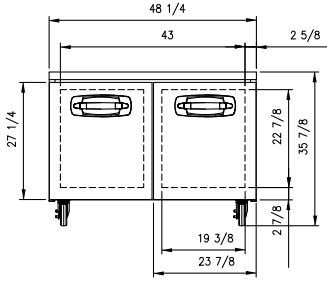

FRONT VIEW

MBUF48

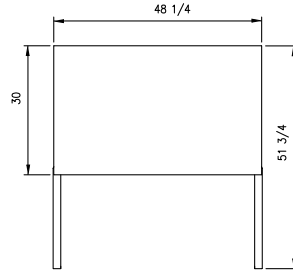

TOP VIEW

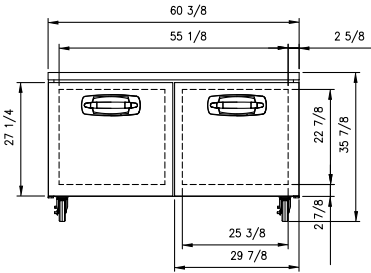

FRONT VIEW

MBUF60

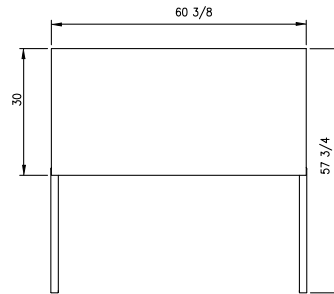

TOP VIEW

SPECIFICATIONS

Models	MBUF27	MBUF48	MBUF60
Crated Weight (lbs) (kg)	143 (65)	220 (100)	254 (115)
Crated Height (in) (mm)	36 (914)	36 (914)	36 (914)
Crated Width (in) (mm)	30-1/8 (765)	51-1/4 (1302)	63 (1600)
Crated Depth (in) (mm)	33-1/2 (851)	33-1/2 (851)	33-1/2 (851)
Interior Height (in) (mm)	25-1/2 (648)	25-1/2 (648)	25-1/2 (648)
Interior Width (in) (mm)	23 (584)	43-3/4 (1111)	55-7/8 (1419)
Interior Depth (in) (mm)	21-1/2 (546)	21-1/2 (546)	21-1/2 (546)
Overall Height (in) (mm)	35-7/8 (911)	35-7/8 (911)	35-7/8 (911)
Overall Width (in) (mm)	27-1/2 (699)	48-1/4 (1226)	60-3/8 (1534)
Overall Depth (in) (mm)	30 (762)	30 (762)	30 (762)
Gross Cubage (CuFt) (L)	6.0 (170)	11.4 (323)	14.6 (413)
Number of Shelves	1	2	2
Shelf Area (SqFt) (SqM)	3.4 (0.32)	6.5 (0.60)	8.3 (0.77)
Number of Casters	4	4	4
Condensing Unit Size	1/5 HP	1/2 HP	1/2 HP
Refrigerant	R290	R290	R290
Electrical Characteristics	115/60/1	115/60/1	115/60/1
Cord and Plug Furnished	Yes	Yes	Yes
NEMA Plug Configuration	5-15P	5-15P	5-15P
Total Amp Draw	3.5	7.5	7.5

Specifications subject to change without notice.

OPTIONAL OVERSHELF SPECIFICATIONS

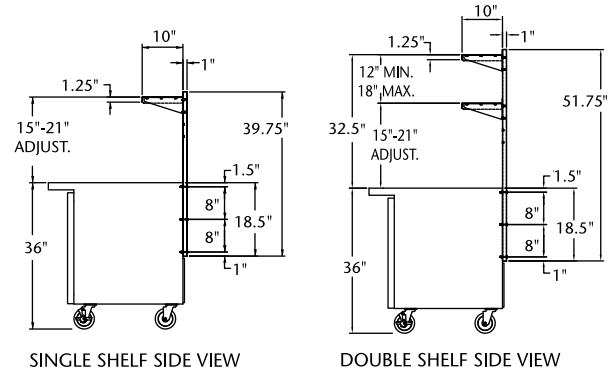
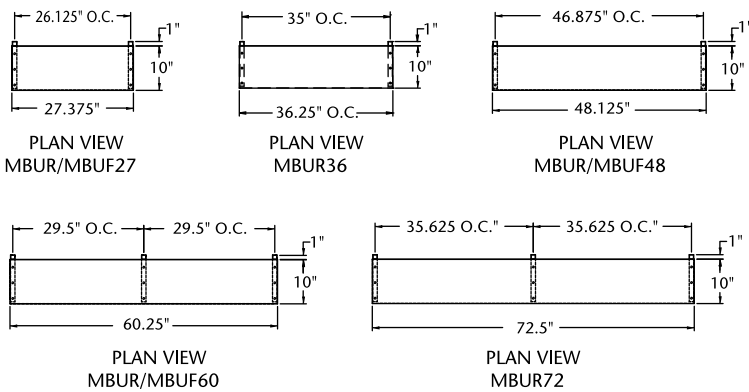

BID SPECIFICATIONS

Item no. MBU____. Provide _____ Undercounter/worktable refrigerator/ freezer(s), Master-Bilt® model no. MBU_____.

Undercounter will feature a stainless steel interior and exterior. Other standard features will include adjustable heavy-duty shelves (one per door), self-closing door with

recessed pocket handle and 6" overall height casters.

The refrigeration system will be bottom mounted and self-contained.

Refrigerant for all models will be R290. The temperature range will be 34° to 38°F (1° to 3° C) for refrigerators and -5° to 0°F (-20° to

-17°C) for freezers.

Undercounter to have standard limited three year parts and labor with additional two year coverage on compressor part.

Undercounter to be UL & C-UL listed and ETL Sanitation listed.

NOTE: Cabinet designed for optimum performance in air-conditioned area at 75°F ambient and 55% relative humidity. All specifications subject to change without notice.

MB MASTER-BILT®
Refrigeration Solutions

908 Highway 15 North • New Albany, MS 38652
PHONE: 800-647-1284 or 662-534-9061 • FAX: 800-232-3966 or 662-534-6049 • www.master-bilt.com

RSG
Refrigerated Solutions Group